

MEGI

Huštawka ogrodowa
Instrukcja montażu i obsługi

PL EN CZ











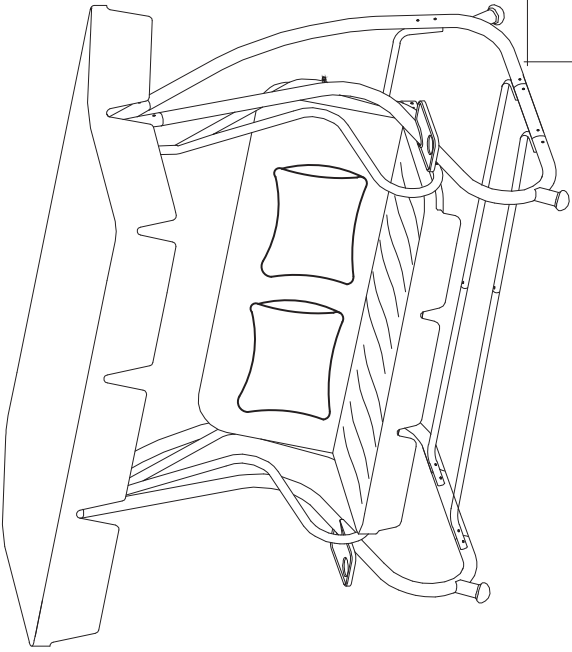
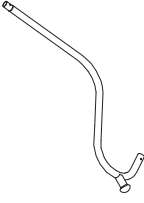









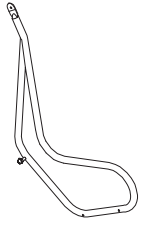
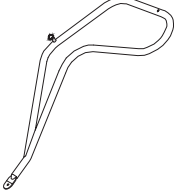
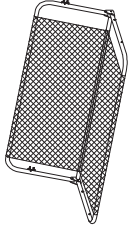



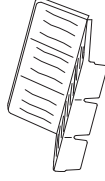



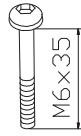

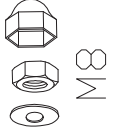

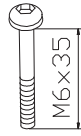
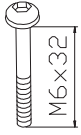

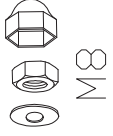
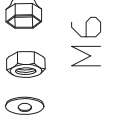
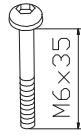
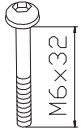

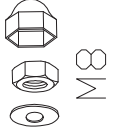
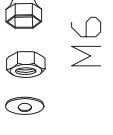
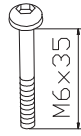
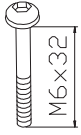

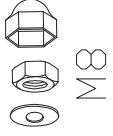
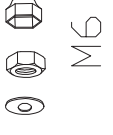
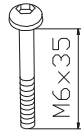
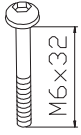

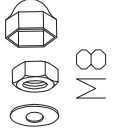
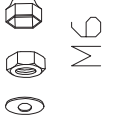
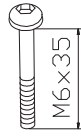
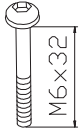

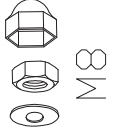
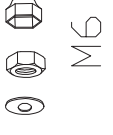
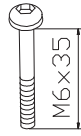
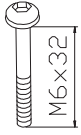

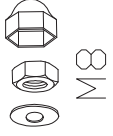
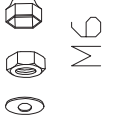
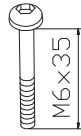
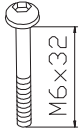

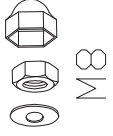
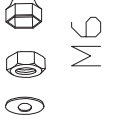
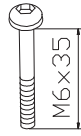
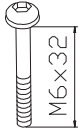

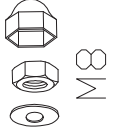
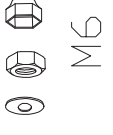
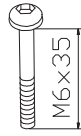
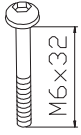

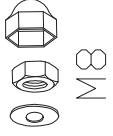
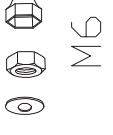
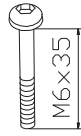
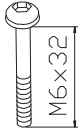

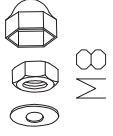
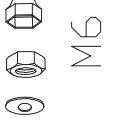
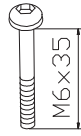
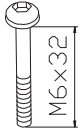

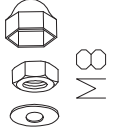
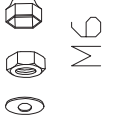
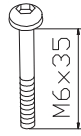
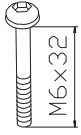

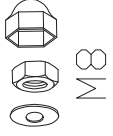
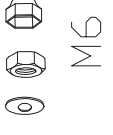
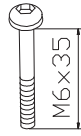
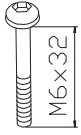

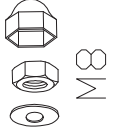
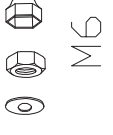
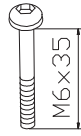
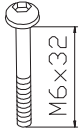

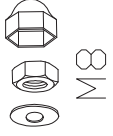
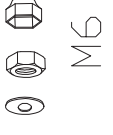
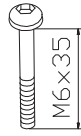
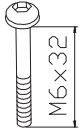

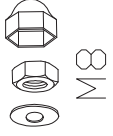
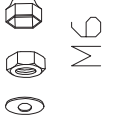
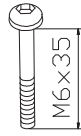
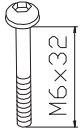

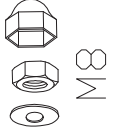
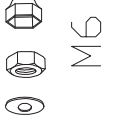
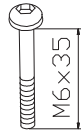
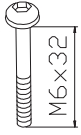

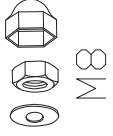
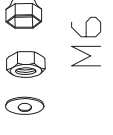
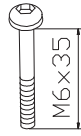
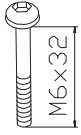

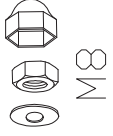
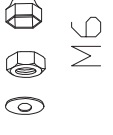
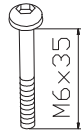
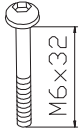

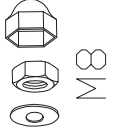
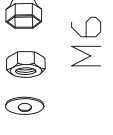
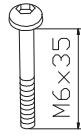
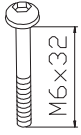

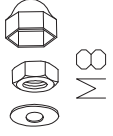
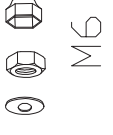
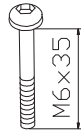
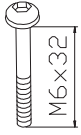

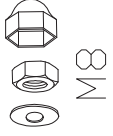
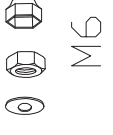
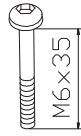
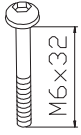

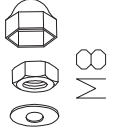
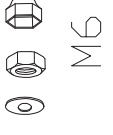
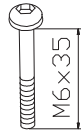
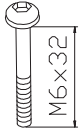

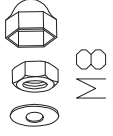
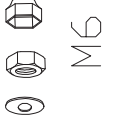
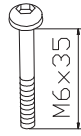
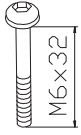

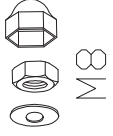
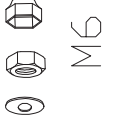
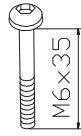
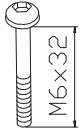

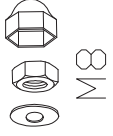
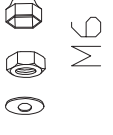
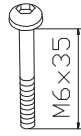
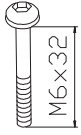

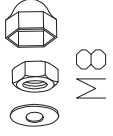
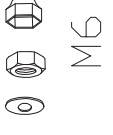
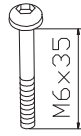
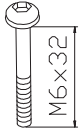

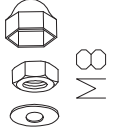
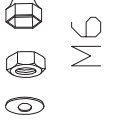
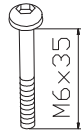
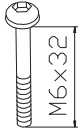

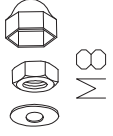
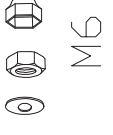
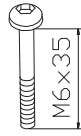
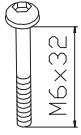

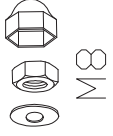
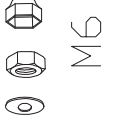
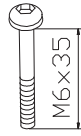
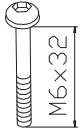

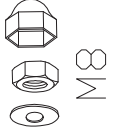
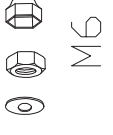
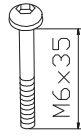
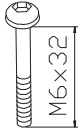

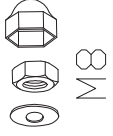
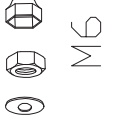
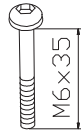
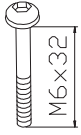

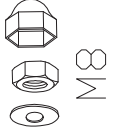
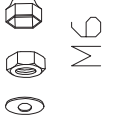
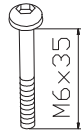
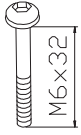

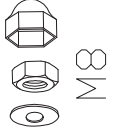
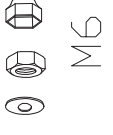
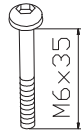
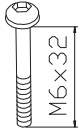

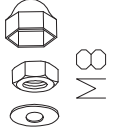
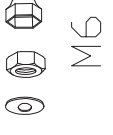
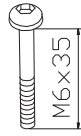
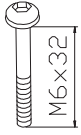

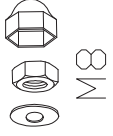
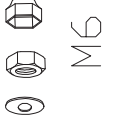
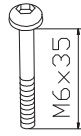
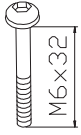

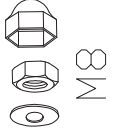
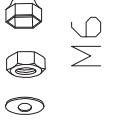
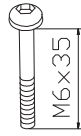
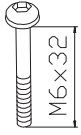

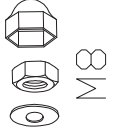
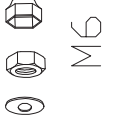
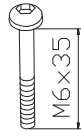
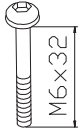

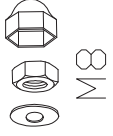
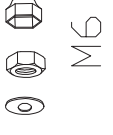
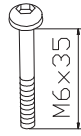
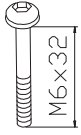

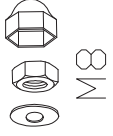
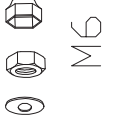
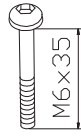
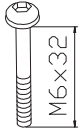

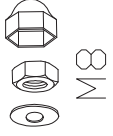
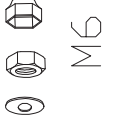
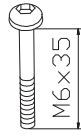
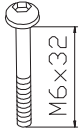
Garden Swing
Assembly and use instructions

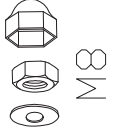
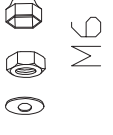
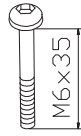
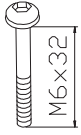
Zahradní houpačka
Návod k instalaci a obsluze

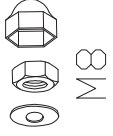
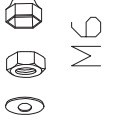
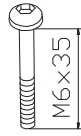
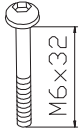
Importer:
Mirpol sp. z o.o.
ul. Ciasna 3, 35-232 Rzeszów
biuro@mirpol.rzeszow.pl
www.mirpol.rzeszow.pl

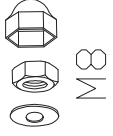
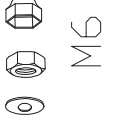
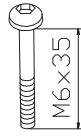
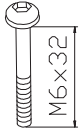
Mirpol

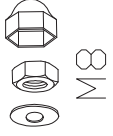
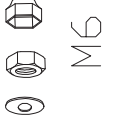
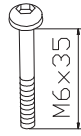
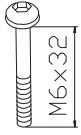
LISTA CZĘŚCI / PARTS LIST / SEZNAM DÍLŮ

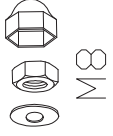
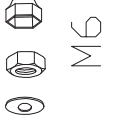
		A 2	B 2	C 1	D 1
					
		E 1	F 1	G 2	H 2
					
		I 1	I 1	J 1	K 2
					
L 2	M 2	N 1	O 1	P 1	
					
		Q 1	R 2	S 2	T 2
					
5	6	7	8	9	
					
1	2	2	25	4	
					
1	2	2	25	4	
					
1	2	2	25	4	
					
1	2	2	25	4	
					
1	2	2	25	4	
					
1	2	2	25	4	
					
1	2	2	25	4	
					
1	2	2	25	4	
					
1	2	2	25	4	
					
1	2	2	25	4	
					
1	2	2	25	4	
					
1	2	2	25	4	
					
1	2	2	25	4	
					
1	2	2	25	4	
					
1	2	2	25	4	
					
1	2	2	25	4	
					
1	2	2	25	4	
					
1	2	2	25	4	
					
1	2	2	25	4	
					
1	2	2	25	4	
					
1	2	2	25	4	
					
1	2	2	25	4	
					
1	2	2	25	4	
					
1	2	2	25	4	
					
1	2	2	25	4	
					
1	2	2	25	4	
					
1	2	2	25	4	
					
1	2	2	25	4	
					
1	2	2	25	4	
					
1	2	2	25	4	
					
1	2	2	25	4	
					
1	2	2	25	4	
					
1	2	2	25	4	
					
1	2	2	25	4	
					
1	2	2	25	4	
					
1	2	2	25	4	
					
1	2	2	25	4	
					
1	2	2	25	4	
					
1	2	2	25	4	
					
1	2	2	25	4	
					
1	2	2	25	4	
					
1	2	2	25	4	
					
1	2	2	25	4	
					
1	2	2	25	4	
					

1

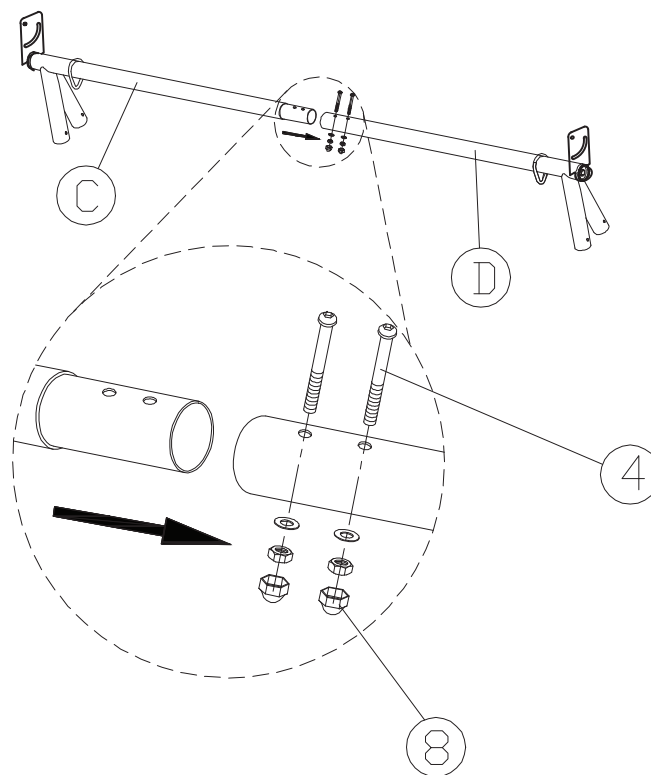

2

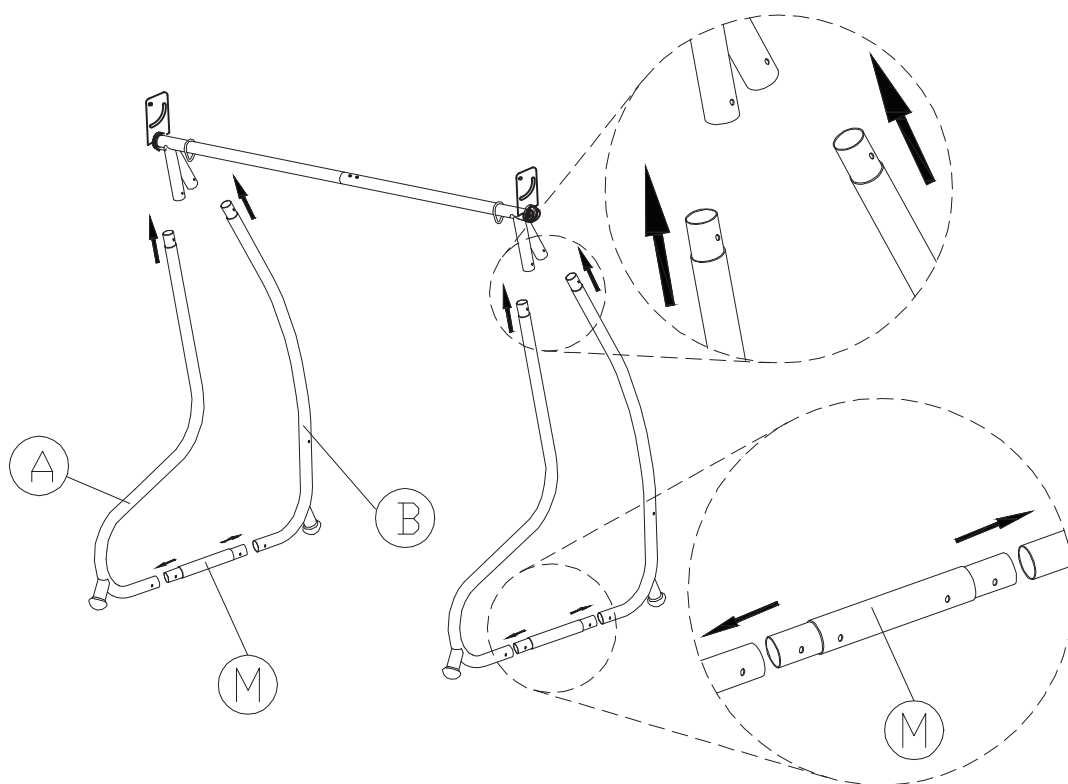

3

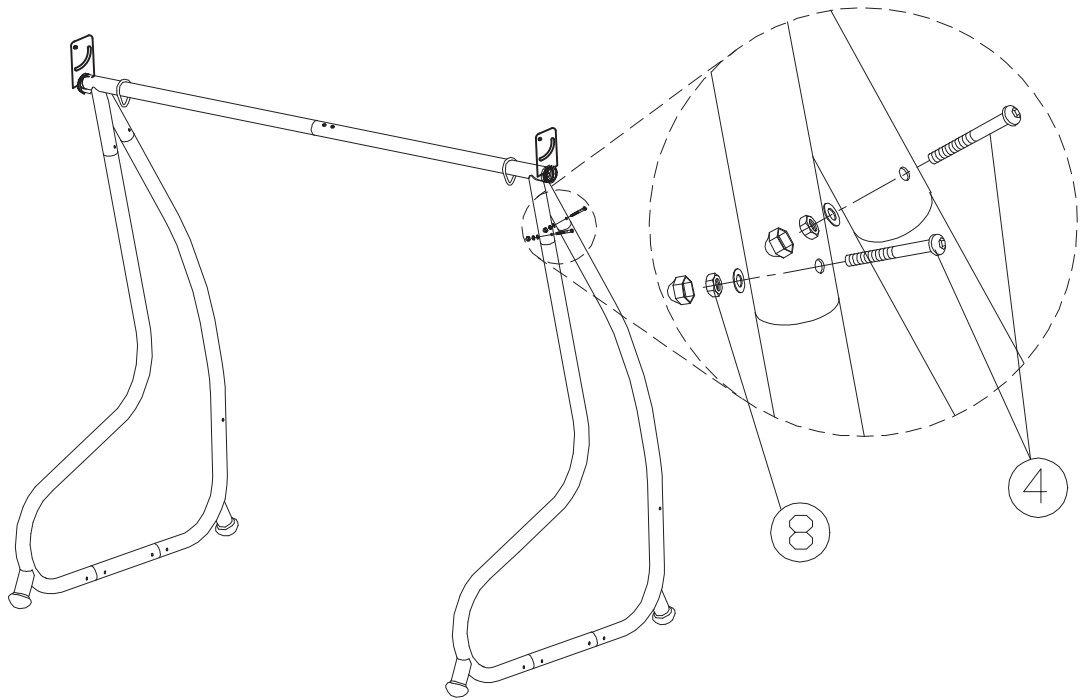

4

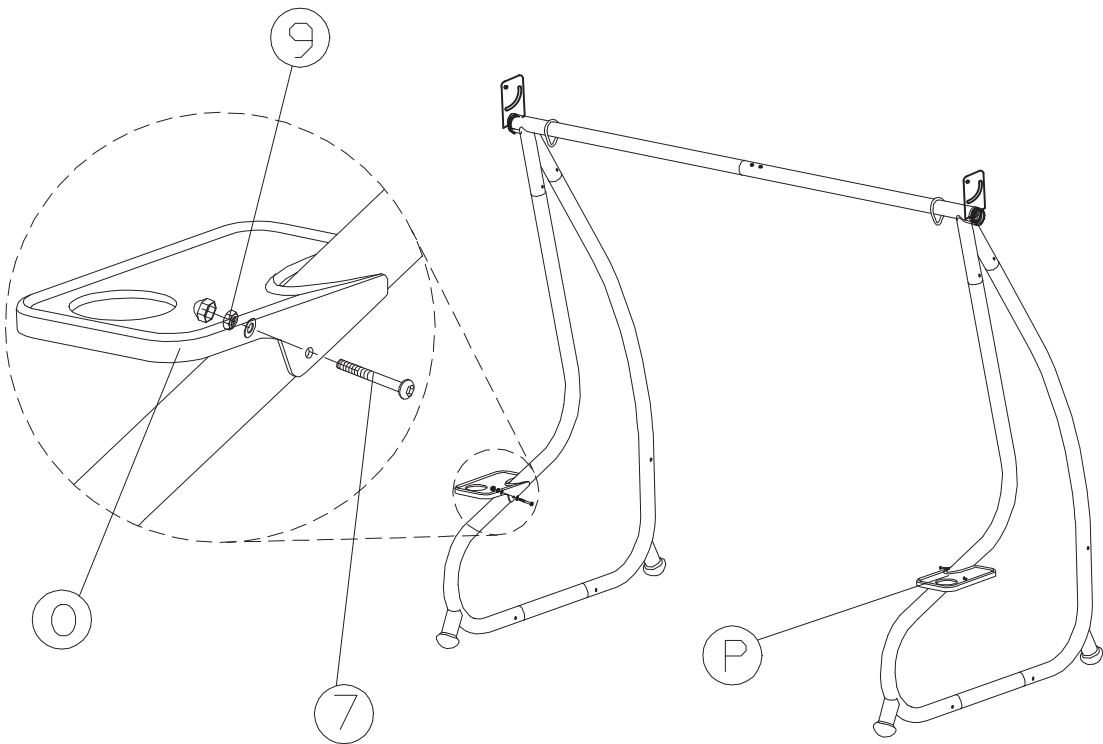

5

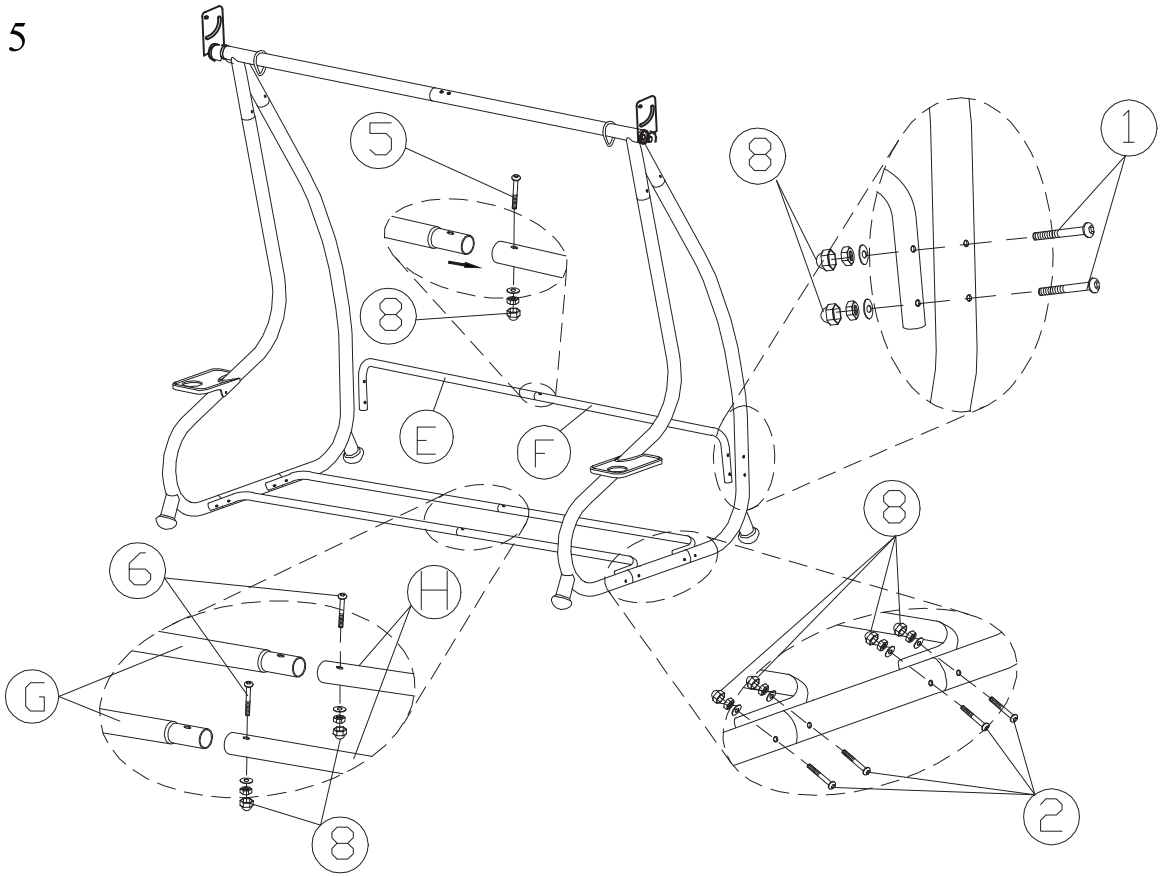

6

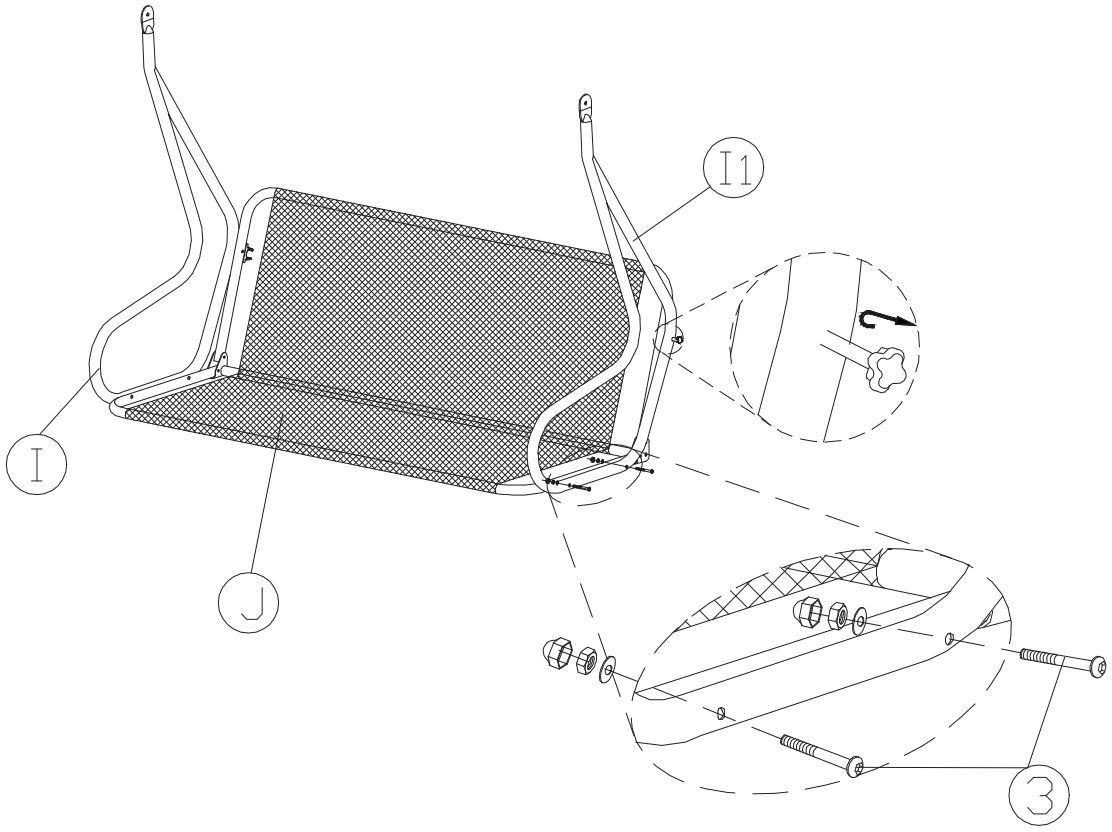

9

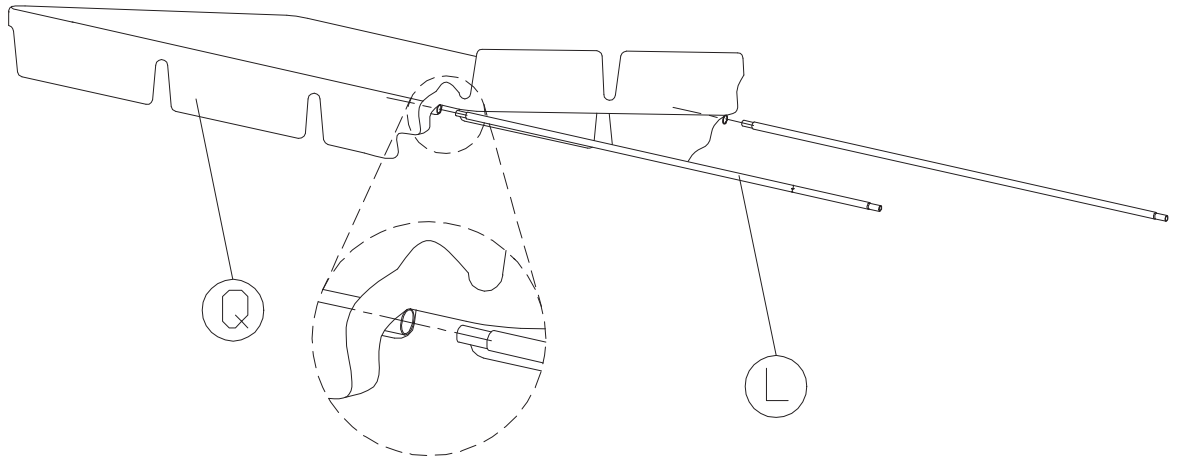

10

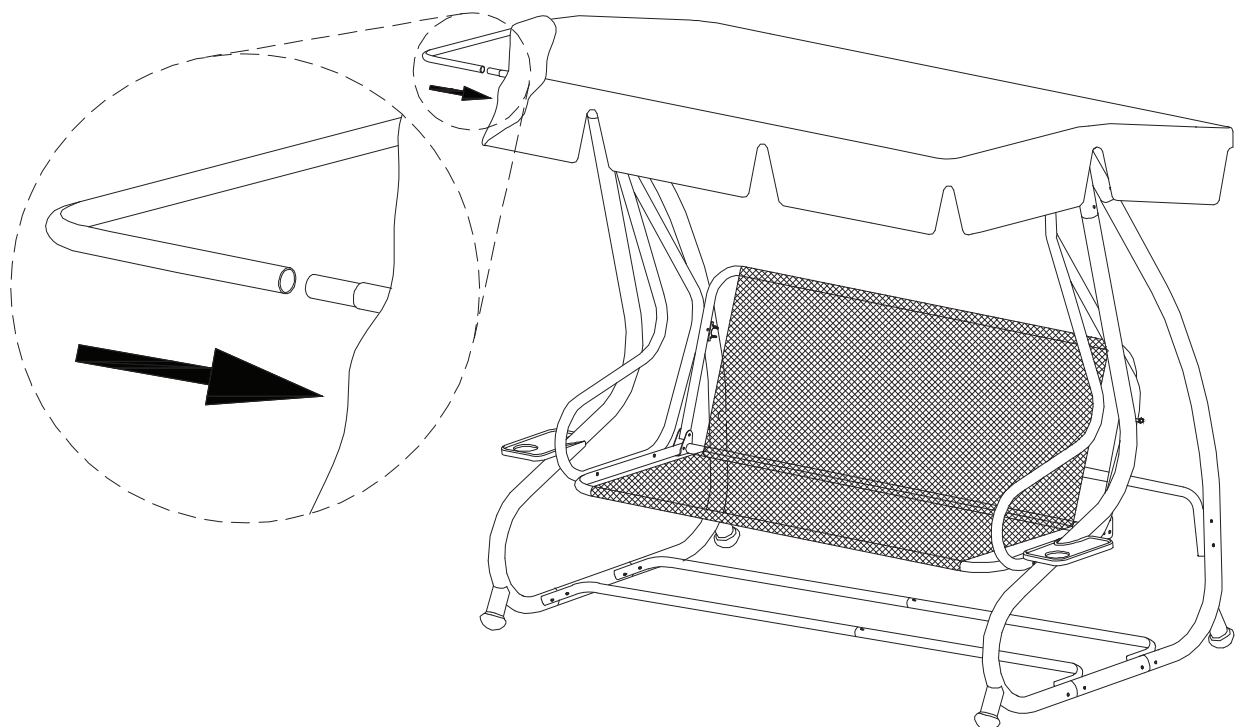

11

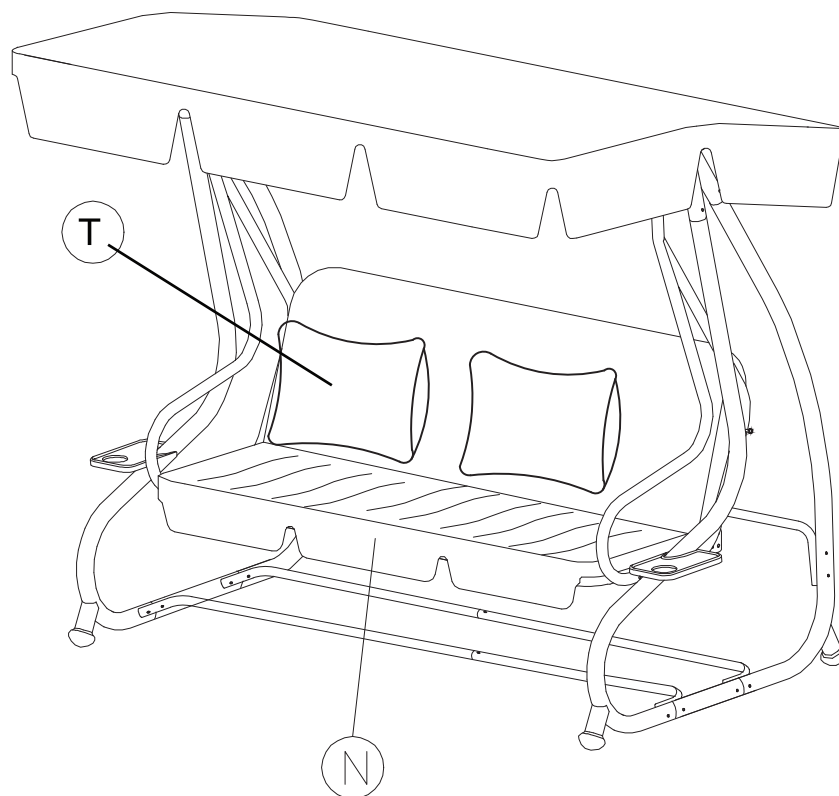

12

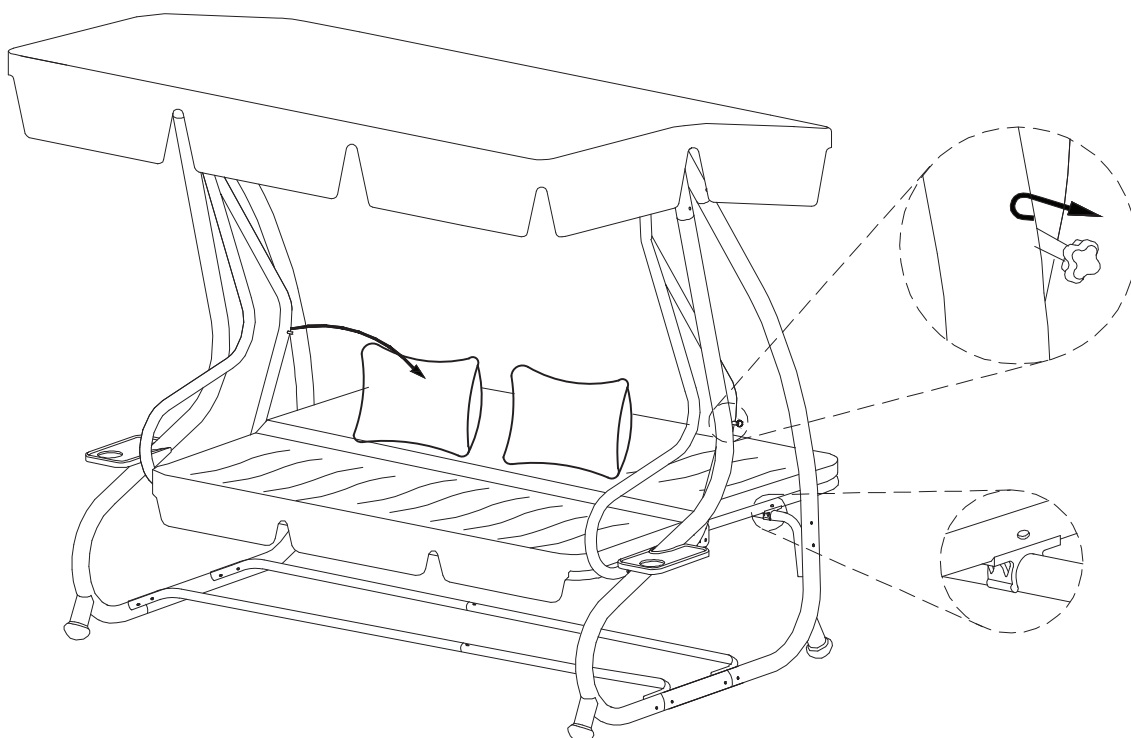

INFORMACJE NA TEMAT UŻYTKOWANIA HUŚTAWEK OGRODOWYCH

WAŻNE! Zachować do późniejszego stosowania: uważnie przeczytać.

Przeznaczenie

Produkt przeznaczony do użytku domowego na zewnątrz, w ogrodach, trasach, ogrodach zimowych.

Produkt nie jest przeznaczony do użytku komercyjnego (np. hotele, restauracje itp.), czy do instalowania na publicznych placach zabaw.

Zasady użytkowania

Maksymalne łączne obciążenie statyczne to 300 kg.

Użytkowanie i montaż powinny odbywać się na suchym, twardym i równym podłożu. Przed montażem zapewnij wystarczającą wolną przestrzeń, min. 2,5m z dala od źródeł ognia i wszelkich struktur takich jak ogrodzenia, bramy, garaże, domy, zwisające gałęzie itp.

Zarówno montaż jak i konserwacja powinny być dokonywane wyłącznie przez osoby dorosłe, do zmontowania tego modelu zalecany jest udział 2 dorosłych osób, wskazane użycie rękawic ochronnych. Przenosić w min 2 osoby, przed przeniesieniem zdemontuj siedzisko!

Przed rozpoczęciem użytkowania upewnij się, że wszystkie złącza są trwale i całkowicie zamocowane a śruby dokręcone. Zaniechanie może doprowadzić do uszkodzenia elementów konstrukcji a w konsekwencji do wypadkówi urazów użytkowników.

Nie wieszaj żadnych ciężarów na ramie lub daszku, nie stawaj na siedzisku, nie narażaj go na silne punktowe napęcia.

Nie pozwól by dzieci bawiły się w pobliżu huśtawki.

Uwaga!

Podczas użytkowania nie wolno wkładać nóg lub rąk pomiędzy siedzisko a ramą huśtawki. Unikaj nadmiernych wychyleń w tył i przód - grozi to utratą stabilności. Nie doprowadzaj do ruchów wzdłużnych siedziska - między ramą siedziskiem zawsze musi być zachowana przestrzeń.

W razie wykrycia wad lub uszkodzeń natychmiast zaprzestań użytkowania przedmiotu

Zabrania się wprowadzania jakichkolwiek zmian konstrukcyjnych!

W celu ochrony przed wpływem niekorzystnych warunków atmosferycznych (śnieg, deszcz, mróz, nadmierne słońce) a także po zakończeniu użytkowania, lub w okresie zimowym przenieść w suche, czyste i zadaszone miejsce.

Daszek huśtawki służy ochronie przed słońcem - nie zapewnia ochrony przed opadami. W razie wystąpienia opadów lub silnego wiatru daszek i poduszki powinny zostać zdemontowane. Mokrego poszycia nie należy składać do kartonu przed wysuszeniem!

Huśtawki nie przymocowanej na stałe do podłoża nie należy pozostawiać gdy istnieje ryzyko wystąpienia silnych wiatrów, grozi to uszkodzeniem konstrukcji którego nie obejmuje gwarancja!

WAŻNE! Nie wystawiaj huśtawki na działanie otwartego ognia lub wysokiej temperatury. Nie stawiaj na żadnym z elementów gorących przedmiotów (naczyni kuchennych, kubków z gorącymi napojami itp.) Nie aplikuj na poszycie daszku lub siedziska żadnych substancji mogących dodatkowo zwiększyć łatwopalność.

Czyszczenie i konserwacja

Sprawdzaj okresowo wszystkie śruby i nakrętki, jeśli wykazują ślady nadmiernego zużycia wymień je na nowe.

Czyść wilgotną szmatką przy pomocy wody z mydłem. Dokładnie spłukać i pozostawić do wyschnięcia.

Do czyszczenia nie używać wybielaczy, kwasów lub innych środków ściernych.

Przedmiot wykonany jest z wysokiej jakości materiałów i zabezpieczony farbą. Należy mieć jednak na uwadze, że jeśli będzie pozostawiony na zewnątrz i poddany działaniu warunków atmosferycznych przez dłuższy czas to mogą pojawić się ślady rdzy. Aby zminimalizować ryzyko rdzewienia należy regularnie czyścić elementy stalowe, można również używać past polerskich aby dodatkowo zabezpieczyć powierzchnię.

W razie stwierdzenia większych zarysowań czy ubytków farby miejsce takie należy oczyścić z jakichkolwiek śladów rdzy a następnie zabezpieczyć silikonem, farbą lub lakierem do metalu.

Zawsze zaleca się zabezpieczenie mebla za pomocą odpowiedniego pokrowca gdy nie jest użytkowany.

GARDEN SWING USAGE INFORMATION

IMPORTANT! Keep this manual for future reference.

Purpose

The product is intended for outdoor use; in gardens, patios or winter gardens.

The product is not intended for commercial use (e.g. hotels, restaurants) or for installation on public playgrounds.

Rules of Use

Maximum static user weight is 300 kg

Use and assembly should be performed on dry, even and hard ground. Before assembly, ensure you have enough space, minimum 2.5m from fire sources and different structures such as fences, garages or loose branches.

Assembly and care should be performed by adults only. 2 persons are recommended for the assembly of this product. Safety gloves recommended. Move swing using minimum 2 people. Before moving, disassemble the seat.

Before use, ensure that the construction is stable and all screws are tightened properly. Failure to do so, may lead to damage to structural elements and, as a consequence, to accidents and injuries to users.

Do not hang any weights on the frame or roof of the swing, do not stand on the seat, do not expose to excessive strain.

Do not let children play near the swing.

Note!

During use, do not place arms or legs between the seat and the frame of the swing.

Avoid excessive leaning back and forth – may lead to loss of stability. Do not cause longitudinal movements of the seat – space must be kept between the frame and the seat.

In the event of discovering defects or damage, immediately stop use.

Construction alterations are forbidden.

To protect from unwanted atmospheric conditions (snow, rain, frost, excessive sunlight) at the end of use or during the winter season, move product to a dry, covered place.

Swing roof protects from sunlight – it does not offer cover during rain. In the event of a heavy storm or excessive rain, disassemble the roof and pillow. Wet material should not be put into packaging carton, before drying!

Swings that are not permanently attached to the ground should not be left when there is a risk of strong winds, as this may damage the structure, which is not covered by the warranty.

IMPORTANT! Do not expose the swing to open fire or high temperature. Do not place any hot items on any of the swing elements (kitchen dishes, cups with hot beverages). Do not apply any substances to the roof or seat cover that may additionally increase flammability.

Cleaning and care

Periodically check all bolts and nuts, if they show signs of excessive wear replace them with new ones.

Clean with damp cloth with water and soap. Rinse thoroughly and leave to dry.

Do not use abrasive or bleach substances for cleaning.

The product is made of high quality materials and protected with paint. Note, however, if the product is left outside to atmospheric conditions with no protection or care, for long amounts of time, signs of rust may appear.

It is always recommended to use appropriate cover, if product is not in use.

INFORMACE O POUŽITÍ ZAHRADNÍCH HOUPAČEK

DŮLEŽITÉ! Uchovejte pro pozdější použití: čtěte pozorně.

Určení

Výrobek je určen pro domácí použití, venku, na zahradách, terasách, zimních zahradách.

Výrobek není určen pro komerční použití (např. hotely, restaurace atd.), nebo k instalaci na veřejném hřišti.

Podmínky použití

Maximální celkové statické zatížení je 300 kg.

Použití a montáž by měla být na suchém, tvrdém a rovném povrchu. Před montáží zajistěte dostatečný volný prostor, min. 2,5 m od zdroje požáru a jakékoli konstrukce, jako jsou ploty, brány, garáže, domy, převislé větve atd. Montáž i údržba by měla být prováděna pouze dospělou osobou. K sestavení tohoto modelu se doporučuje účast 2 dospělých osob, doporučuje se používat ochranné rukavice.

Přenášet sestavený produkt mohou min 2 osoby. Sedák houpačky musí být pro přenos demontován.

Před použitím se ujistěte, že všechny spoje jsou trvale a zcela připojeny a šrouby utažené. Pokud tak neučiníte, může dojít k poškození konstrukčních prvků a následně k nehodě a zranění uživatelů.

Nezavěšujte žádné zátěže na rám nebo stříšku, nestoupejte na sedadlo, nevystavujte jej silné bodové zátěži.

Nenechávejte děti hrát si v blízkosti houpačky.

Pozor!

Při používání nedávejte nohy ani ruce mezi sedadlo a houpací rám. Vyhybejte se nadměrným vychýlkám tam a zpět - může to mít za následek ztrátu stability. Nedělejte se sedadlem podélné pohyby - mezi rámem a sedadlem musí být vždy zachovaný prostor.

Pokud jsou zjištěny závady nebo poškození, okamžitě přestaňte předmět používat.

Je zakázáno provádět jakékoli změny konstrukce!

Abyste chránili produkt před vlivy nepříznivých povětrnostních podmínek (sníh, déšť, mráz, nadměrné slunce), a také po ukončení používání například v zimě, přemístěte produkt na suché, čisté a zastřešené místo. Stříška slouží jako ochrana před sluncem - neposkytuje ochranu před deštěm.

V případě deště nebo silného větru by měla být stříška a polštáře demontovány. Kryt by neměl být vložen do kartonu mokrá! Houpačku, která není pevně připevněna k zemi, byste neměli nechávat nezabezpečenou, pokud hrozí silný vítr. Může dojít k poškození konstrukce, na reklamaci tohoto typu poškození se nevztahuje záruka!

DŮLEŽITÉ! Nevystavujte houpačku otevřenému ohni nebo vysokým teplotám. Nepokládejte na ni žádné horké předměty (kuchyňské nádoby, hrnky s horkými nápoji atd.) Na střechu nebo potah sedačky neaplikujte žádné látky, které mohou zvýšit hořlavost.

Čištění a údržba

Pravidelně kontrolujte všechny šrouby a matice a pokud vykazují známky nadměrného opotřebení, vyměňte je za nové. Čistěte vlhkým hadříkem a mýdlovou vodou. Důkladně opláchněte a nechte uschnout. K čištění nepoužívejte bělidla, kyseliny ani jiné čisticí prostředky. Produkt je vyroben z vysoce kvalitních materiálů a zajištěn barvou. Je však třeba mít na paměti, že stopy rzi se mohou objevit, pokud je produkt ponechán venku a vystaven atmosférickým jevům po delší dobu. Abyste minimalizovali riziko koroze, pravidelně čistěte ocelové části, můžete také použít lešticí pasty k dodatečné ochraně povrchu. V případě větších škrábanců nebo vad laku by mělo být místo očištěno od jakýchkoli stop rzi a poté zajištěno silikonem, barvou nebo kovovým lakem. Pokud nábytek nepoužíváte, vždy se doporučuje jej chránit vhodným krytem.