

esti&esta<sup>®</sup>

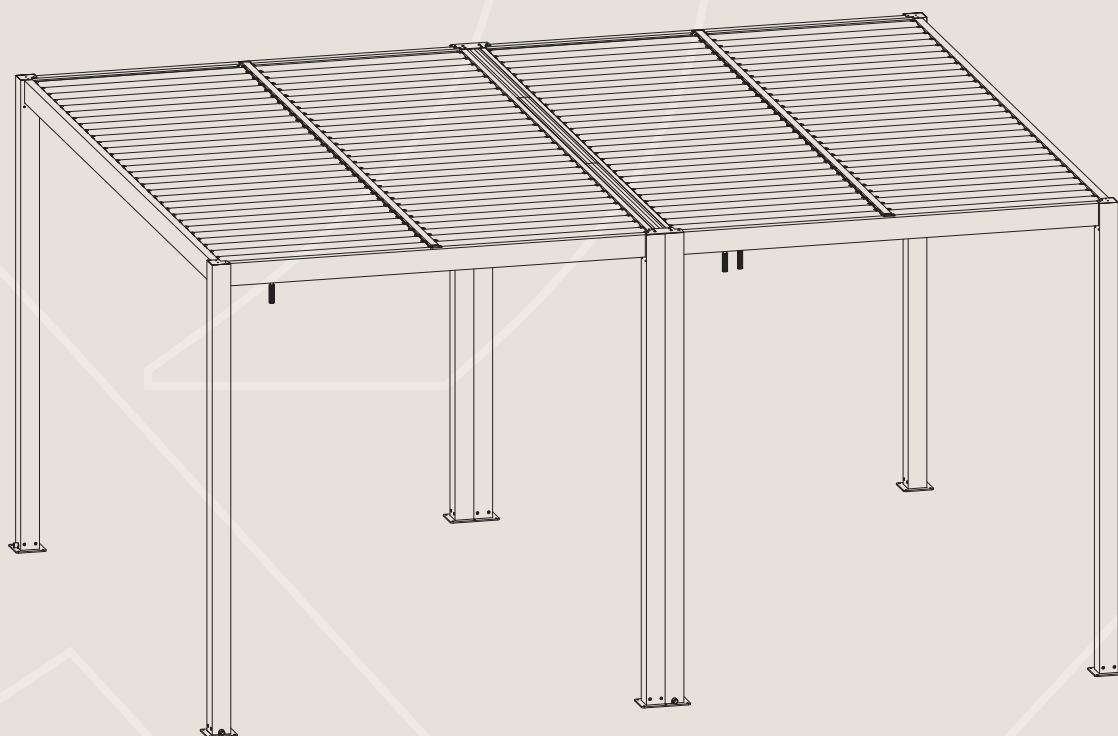



# 0808-1

Zestaw łączników do  
2 pergol manualnych  
8610B

Instrukcja montażu

0808-1 Set of connectors for 2 manual pergolas 8610B  
Assembly instructions

# Lista części / List of parts

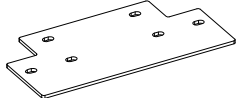
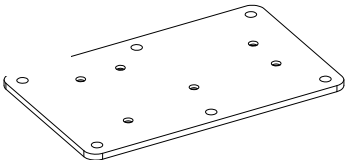
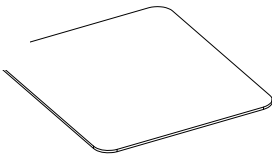
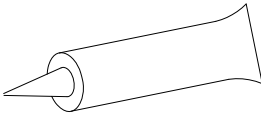
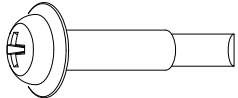
| Nr.<br>Ref. | Szkiec<br>Drawing  | Ilość<br>Qty. |
|-------------|--|---------------|
| A1          | <p>Listwa przeciwdeszczowa 1351 mm<br/>Rain cover plate 1351 mm</p>                | 4             |
| A2          | <p>Listwa przeciwdeszczowa 992 mm<br/>Rain cover plate 992 mm</p>                  | 2             |
| B1          | <p>Płyta osłonowa dwukolumnowa<br/>Two-column cover plate</p>                      | 2             |
| C1          | <p>Podstawa dwukolumnowa<br/>Two-column base plate</p>                           | 2             |
| D           | <p>Wodoodporna naklejka<br/>Waterproof sticker</p>                               | 4             |
| E           | <p>Wodoodporny uszczelniacz<br/>Waterproof sealant</p>                           | 1             |
| S1          | <p>Wkręty samowiercące C-ST4.2x25 mm<br/>Self-drilling screws C-ST4.2x25 mm</p>  | 12            |
|             |  |               |

# Zalecane narzędzia / What you may need?

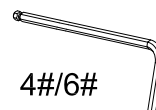
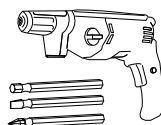
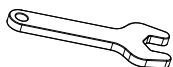
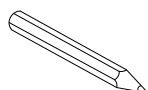
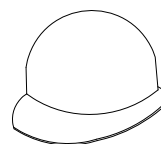
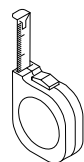
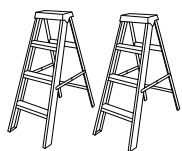

1. Drabina (x2)
2. Miarka
3. Młotkek
4. Rękawice ochronne
5. Wiertarka udarowa (z wiertłem 10mm)
6. Kask ochronny
7. Poziomica
8. Marker
9. Klucz płaski
10. Śrubokręt lub wkrętarka
11. Klucz imbusowy

1. Ladder (x2)
2. Tapeline
3. Mallet
4. Glove
5. Electric screw driver (10mm)
6. Safety hat
7. Level
8. Marker Pen
9. Adjustable wrench
10. Screwdriver or electric screwdriver
11. Allen key

# Instrukcja montażu / Assembly instructions

1

Połącz dwie kolumny przy użyciu dwukolumnowej płyty bazowej. Upewnij się, że otwór odpływowy jednej kolumny pozostaje zamknięty. / Connect the two columns using the dual-column base plate. Make sure the drainage hole on one column remains blocked.

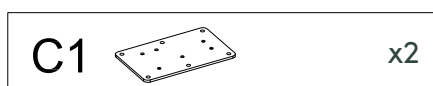
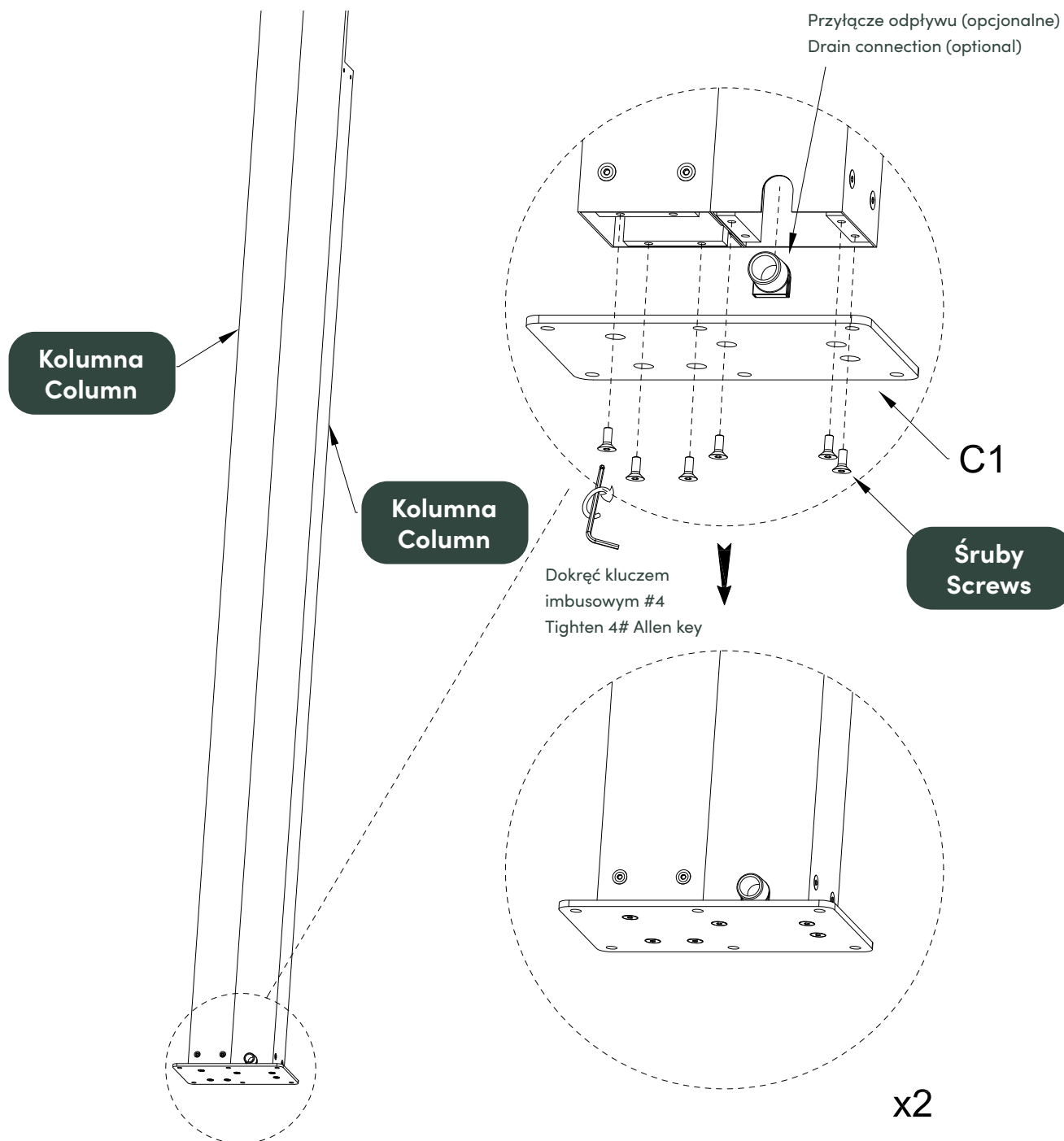

2

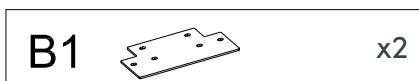
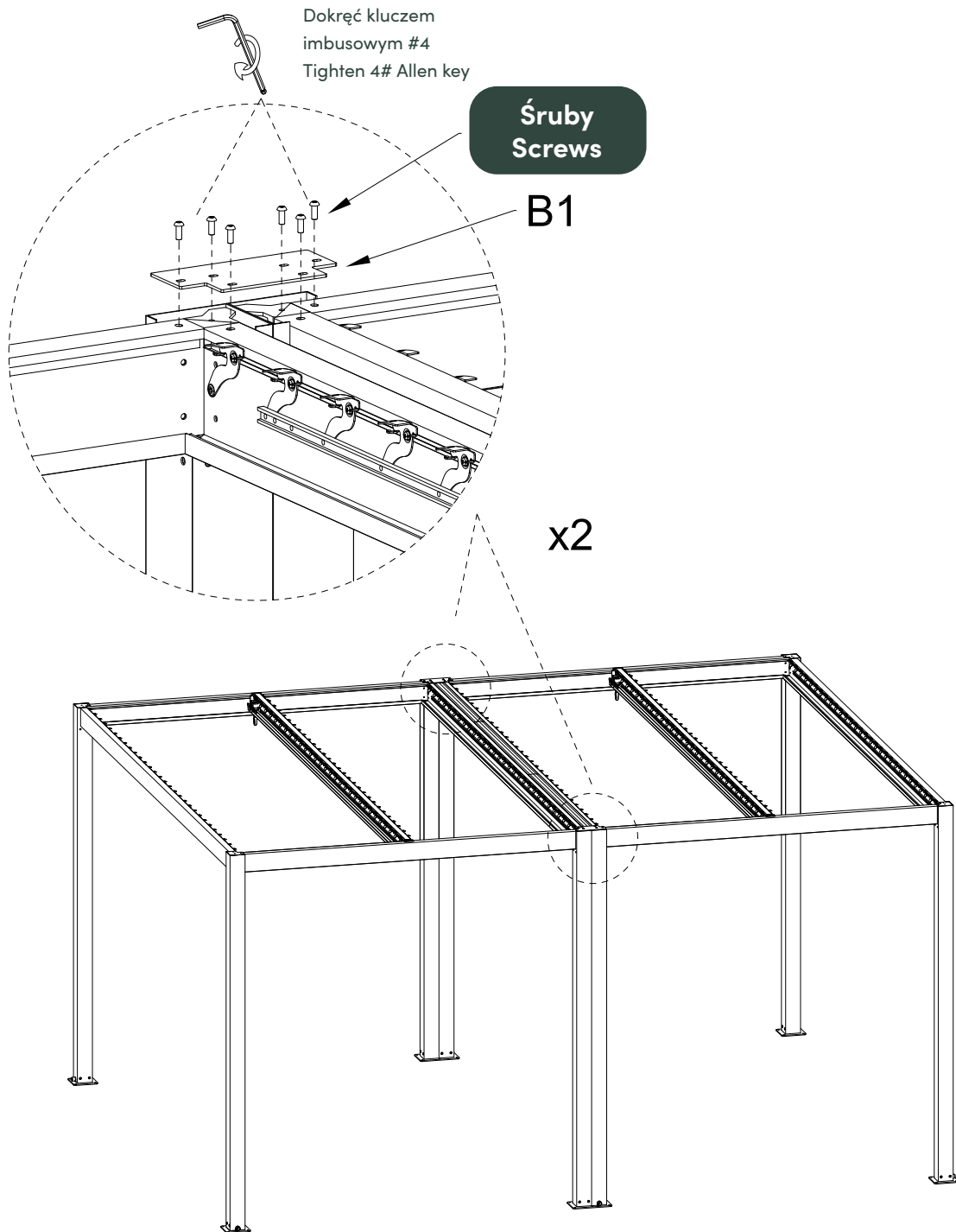

Najpierw zamontuj jedną osłonę filaru, następnie zamontuj wszystkie osłony przeciwdeszczowe, a na końcu zamontuj pozostałą osłonę filaru. / First install one pillar cover, then install all the rain covers, and finally install the remaining pillar cover.

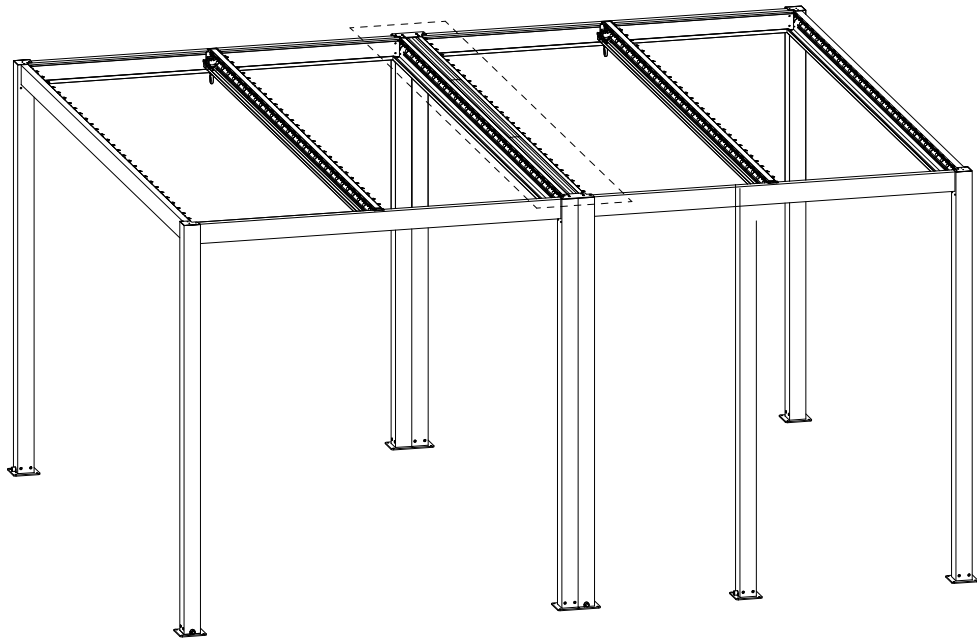
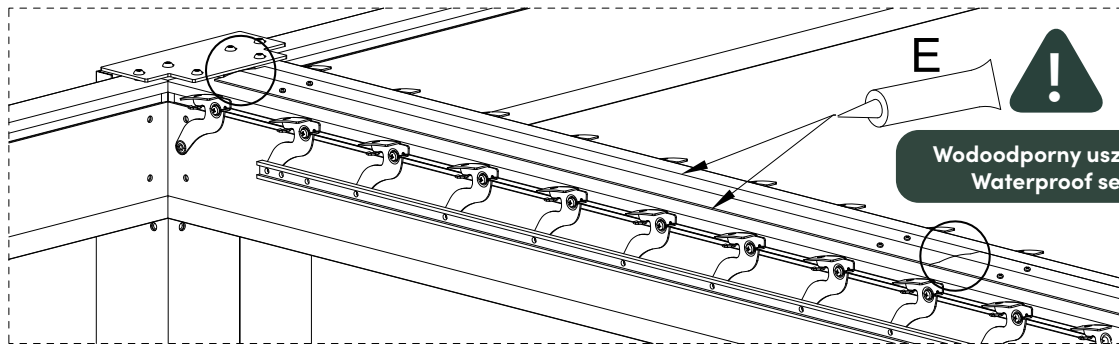
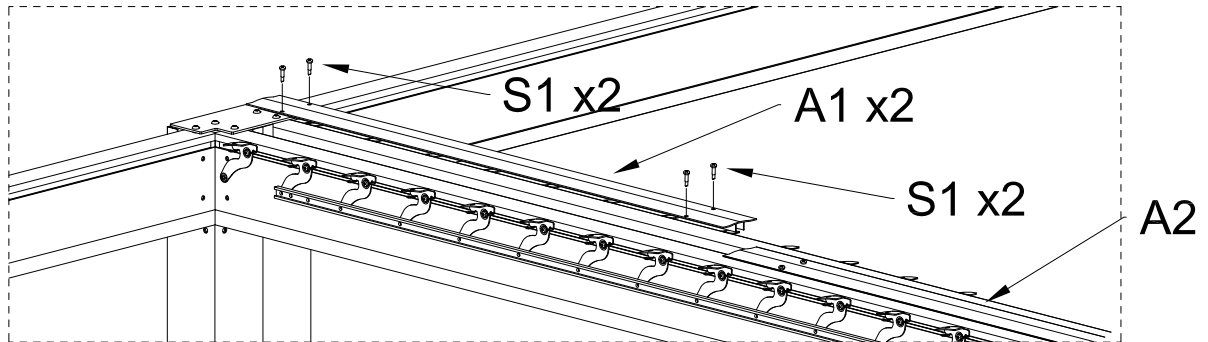

3

Zamontuj panel osłony przeciwdeszczowej i nałóż uszczelniacz wodoodporny na szwach.  
 / Install the rain cover panel and apply waterproof sealant at the seams.

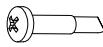

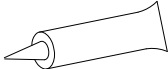
|    |   |    |    |   |     |
|----|---|----|----|---|-----|
| A1 |  | x2 | S1 |  | x12 |
| A2 |  | x1 | E  |  | x1  |

4

Nałóż uszczelniacz wodoodporny i wodoodporną naklejkę wokół otworu odpływowego w celu zwiększenia szczelności. / Apply waterproof sealant and waterproof sticker around the drainage hole for engaged sealing.

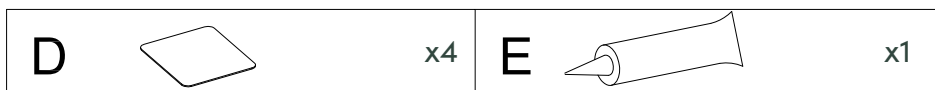
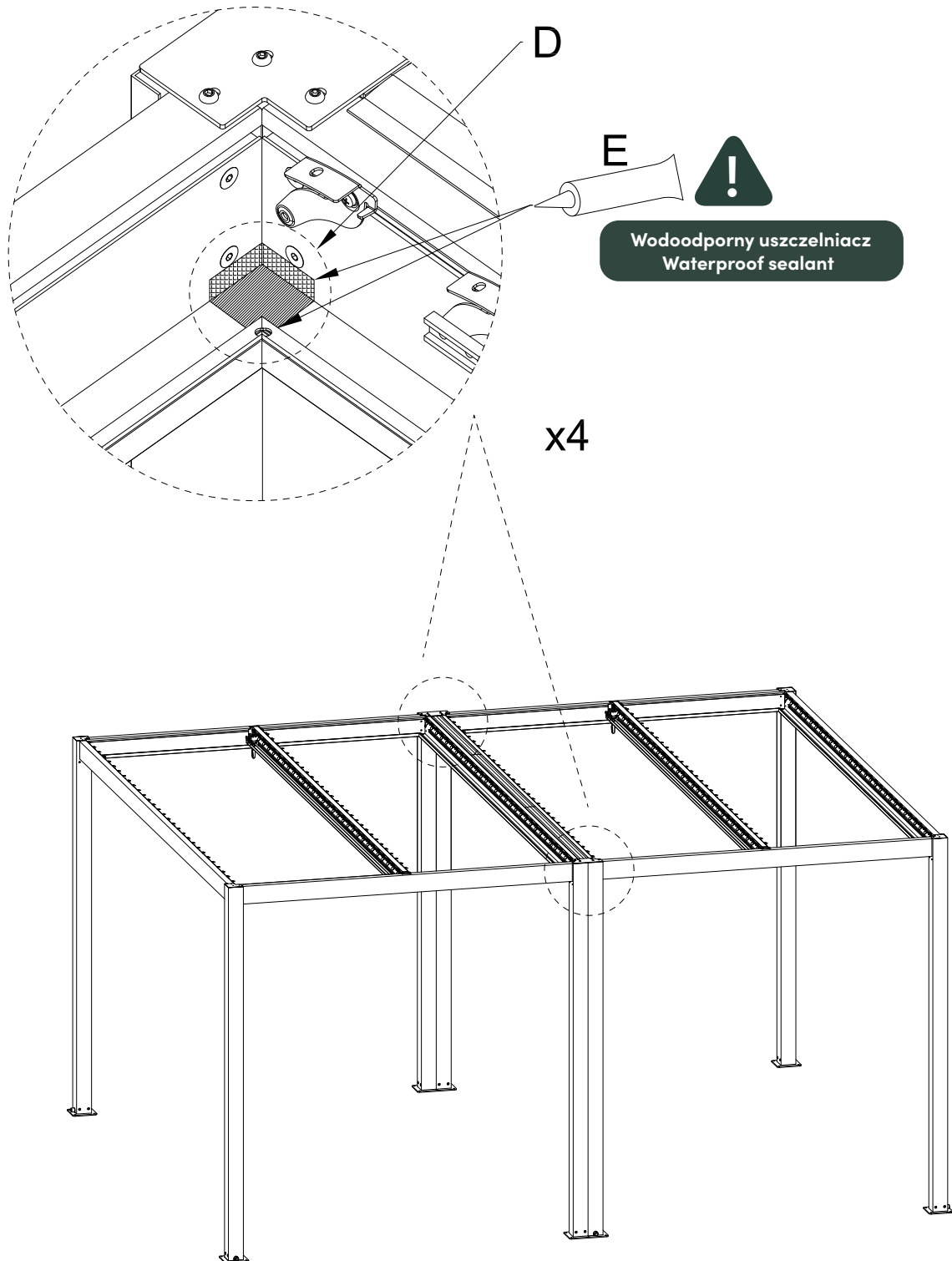

**Producent:**

Mirpol sp. z o.o.  
ul. Ciasna 3, 35-232 Rzeszów  
biuro@mirpol.rzeszow.pl  
www.mirpol.rzeszow.pl  
Made in China

**esti&esta<sup>®</sup>**